



**archiproducts**  
DESIGN AWARDS  
—  
WINNER 2018

# Frame

## Kitchens & workbenches

Salvatore Indriolo, 2018



**Bases / Basi / Basen**

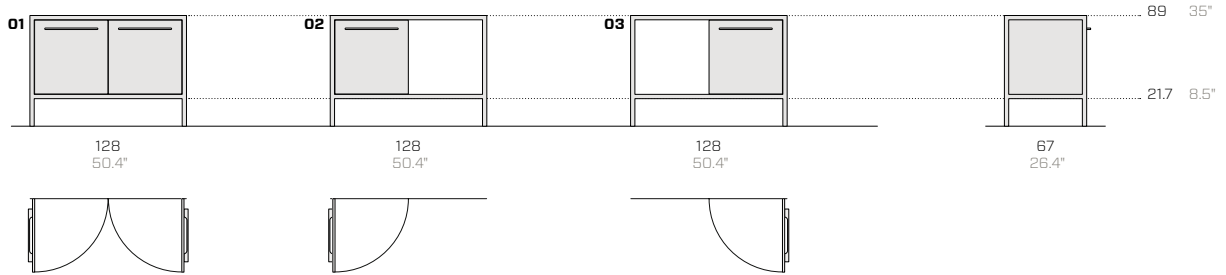

**Top / Top / Abdeckung**

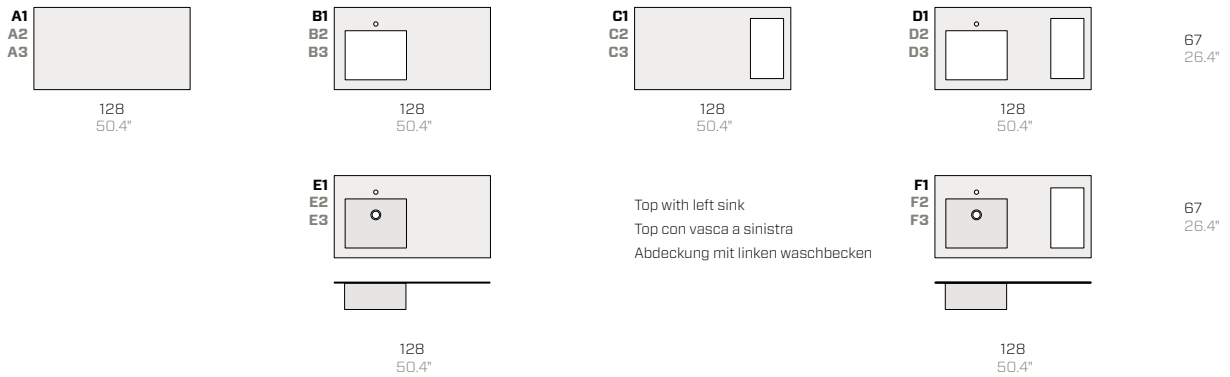

**Top thickness / Spessore dei top / Stärke der Abdeckung**

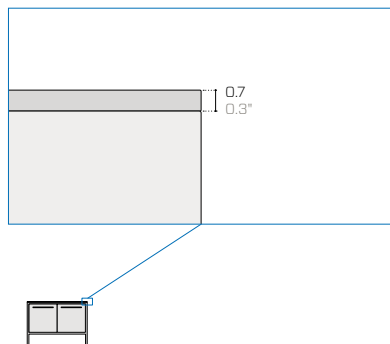

Top made of Fenix  
Top in Fenix  
Abdeckung in Fenix

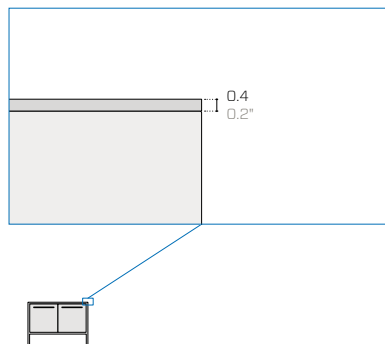

Stainless steel top  
Top in acciaio  
Top in Edelstahl

Product / Prodotto / Produkt				Packaging / Imballo / Verpackung			
No.	Code	Dimensions (w-d-h)	Weight	Dimensions (w-d-h)	Weight	Vol pkg	
N.	Codice	Dimensioni (l-p-h)	Peso	Dimensioni (l-p-h)	Peso	Vol. collo	
Nr.	Code	Abmessungen (b-t-h)	Gewicht	Abmessungen (b-t-h)	Gewicht	Vol. Kollo	
		cm	kg	cm	kg	mc	
<b>Bases / Basi / Basen</b>							
<b>O1</b>	FR85	128 67 89	60	132 71 119	70	1.20	
<b>O2</b>	FR84S	128 67 89	55	132 71 119	65	1.20	
<b>O3</b>	FR84D	128 67 89	55	132 71 119	65	1.20	
Top made of Fenix / Top in Fenix / Abdeckung in Fenix							
<b>A1</b>	FRB21F	128 67 0.7	13	143 82 17	18	0.20	
<b>B1</b>	FRB22F	128 67 0.7	13	143 82 17	18	0.20	
<b>C1</b>	FRB23F	128 67 0.7	13	143 82 17	18	0.20	
<b>D1</b>	FRB24F	128 67 0.7	13	143 82 17	18	0.20	
<b>E1</b>	FRB25F	128 67 0.7	16	143 82 30	21	0.40	
<b>F1</b>	FRB26F	128 67 0.7	16	143 82 30	21	0.40	
Satin finish stainless steel top (Barazza) / Top in acciaio Inox satinato (Barazza) / Abdeckung in Edelstahl mit Satin-Finish (Barazza)							
<b>A2</b>	FRB31S	128 67 0.4	27	137 80 21	37	0.30	
<b>B2</b>	FRB32S	128 67 0.4	20	137 80 21	30	0.30	
<b>C2</b>	FRB33S	128 67 0.4	23	137 80 21	33	0.30	
<b>D2</b>	FRB34S	128 67 0.4	17	137 80 21	27	0.30	
<b>E2</b>	FRB35S	128 67 0.4	25	137 80 50	35	0.60	
<b>F2</b>	FRB36S	128 67 0.4	22	137 80 50	32	0.60	
Vintage finish stainless steel top (Barazza) / Top in acciaio Inox Vintage (Barazza) / Top in Edelstahl mit Vintage-Finish (Barazza)							
<b>A3</b>	FRB41V	128 67 0.4	27	137 80 21	37	0.30	
<b>B3</b>	FRB42V	128 67 0.4	20	137 80 21	30	0.30	
<b>C3</b>	FRB43V	128 67 0.4	23	137 80 21	33	0.30	
<b>D3</b>	FRB44V	128 67 0.4	17	137 80 21	27	0.30	
<b>E3</b>	FRB45V	128 67 0.4	25	137 80 50	35	0.60	
<b>F3</b>	FRB46V	128 67 0.4	22	137 80 50	32	0.60	

The packaging details are for products that require assembly / I dati di imballo si riferiscono al prodotto smontato / Die Verpackungsdaten beziehen sich auf das unmontierte Produkt

Bases / Basi / Basen

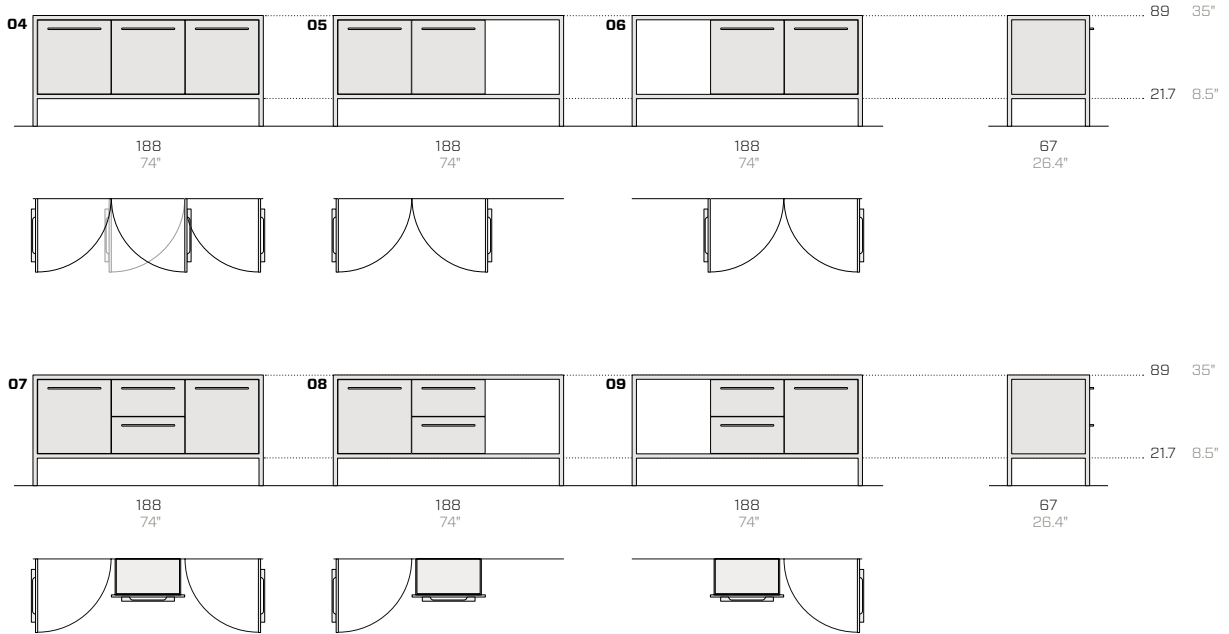

Top / Top / Abdeckung

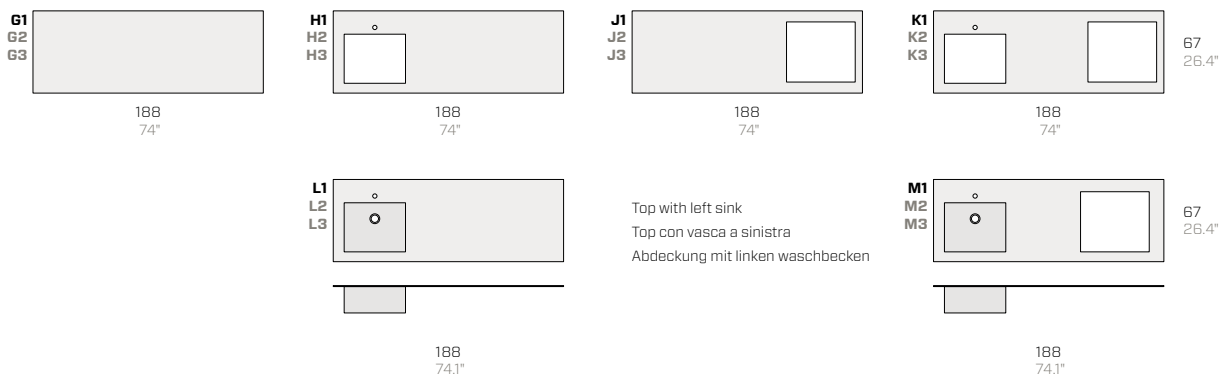

Product / Prodotto / Produkt				Packaging / Imballo / Verpackung			
No.	Code	Dimensions (w-d-h)	Weight	Dimensions (w-d-h)	Weight	Vol pkg	
N.	Codice	Dimensioni (l-p-h)	Peso	Dimensioni (l-p-h)	Peso	Vol. collo	
Nr.	Code	Abmessungen (b-t-h)	Gewicht	Abmessungen (b-t-h)	Gewicht	Vol. Kollo	
		cm	kg	cm	kg	mc	
<b>Bases / Basi / Basen</b>							
<b>04</b>	FR87	188 67 89	92	192 71 119	102	1.70	
<b>05</b>	FR86S	188 67 89	87	192 71 119	97	1.70	
<b>06</b>	FR86D	188 67 89	87	192 71 119	97	1.70	
<b>07</b>	FR83	188 67 89	100	192 71 119	110	1.70	
<b>08</b>	FR82S	188 67 89	95	192 71 119	105	1.70	
<b>09</b>	FR82D	188 67 89	95	192 71 119	105	1.70	
Top made of Fenix / Top in Fenix / Abdeckung in Fenix							
<b>G1</b>	FRB51F	188 67 0.7	19	203 82 17	24	0.30	
<b>H1</b>	FRB52F	188 67 0.7	19	203 82 17	24	0.30	
<b>J1</b>	FRB53F	188 67 0.7	19	203 82 17	24	0.30	
<b>K1</b>	FRB54F	188 67 0.7	19	203 82 17	24	0.30	
<b>L1</b>	FRB55F	188 67 0.7	22	203 82 30	27	0.50	
<b>M1</b>	FRB56F	188 67 0.7	22	203 82 30	27	0.50	
Satin finish stainless steel top (Barazza) / Top in acciaio Inox satinato (Barazza) / Abdeckung in Edelstahl mit Satin-Finish (Barazza)							
<b>G2</b>	FRB61S	188 67 0.4	40	197 80 21	50	0.40	
<b>H2</b>	FRB62S	188 67 0.4	33	197 80 21	43	0.40	
<b>J2</b>	FRB63S	188 67 0.4	31	197 80 21	41	0.40	
<b>K2</b>	FRB64S	188 67 0.4	25	197 80 21	35	0.40	
<b>L2</b>	FRB65S	188 67 0.4	38	197 80 50	48	0.80	
<b>M2</b>	FRB66S	188 67 0.4	30	197 80 50	40	0.80	
Vintage finish stainless steel top (Barazza) / Top in acciaio Inox Vintage (Barazza) / Top in Edelstahl mit Vintage-Finish (Barazza)							
<b>G3</b>	FRB71V	188 67 0.4	40	197 80 21	50	0.40	
<b>H3</b>	FRB72V	188 67 0.4	33	197 80 21	43	0.40	
<b>J3</b>	FRB73V	188 67 0.4	31	197 80 21	41	0.40	
<b>K3</b>	FRB74V	188 67 0.4	25	197 80 21	35	0.40	
<b>L3</b>	FRB75V	188 67 0.4	38	197 80 50	48	0.80	
<b>M3</b>	FRB76V	188 67 0.4	30	197 80 50	40	0.80	

The packaging details are for products that require assembly / I dati di imballo si riferiscono al prodotto smontato / Die Verpackungsdaten beziehen sich auf das unmontierte Produkt

Accessories / Accessori / Zubehör

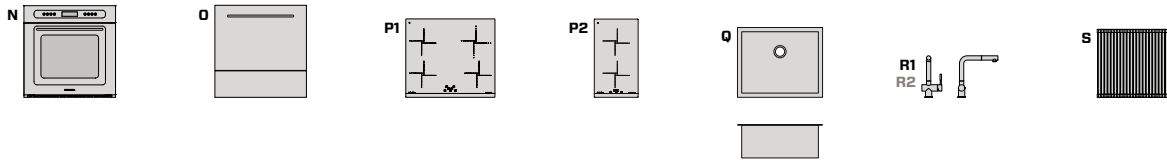

**N.** Oven **O.** Dishwasher **P1-P2.** Induction hob **Q.** Basin **R1-R2.** Tap **S.** Roll-up draining mat.  
**N.** Forno **O.** Lavastoviglie **P1-P2.** Piano a induzione **Q.** Vasca **R1-R2.** Rubinetto **S.** Griglia multiuso avvolgibile.  
**N.** Backofen **O.** Geschirrspülmaschine **P1-P2.** Induktionskochfeld **Q.** Waschbecken **R1-R2.** Wasserhahn **S.** Aufrollbare Abtropfmatte.

Configuration examples and details / Esempi di configurazione e dettagli / Konfigurationsbeispiele und Details

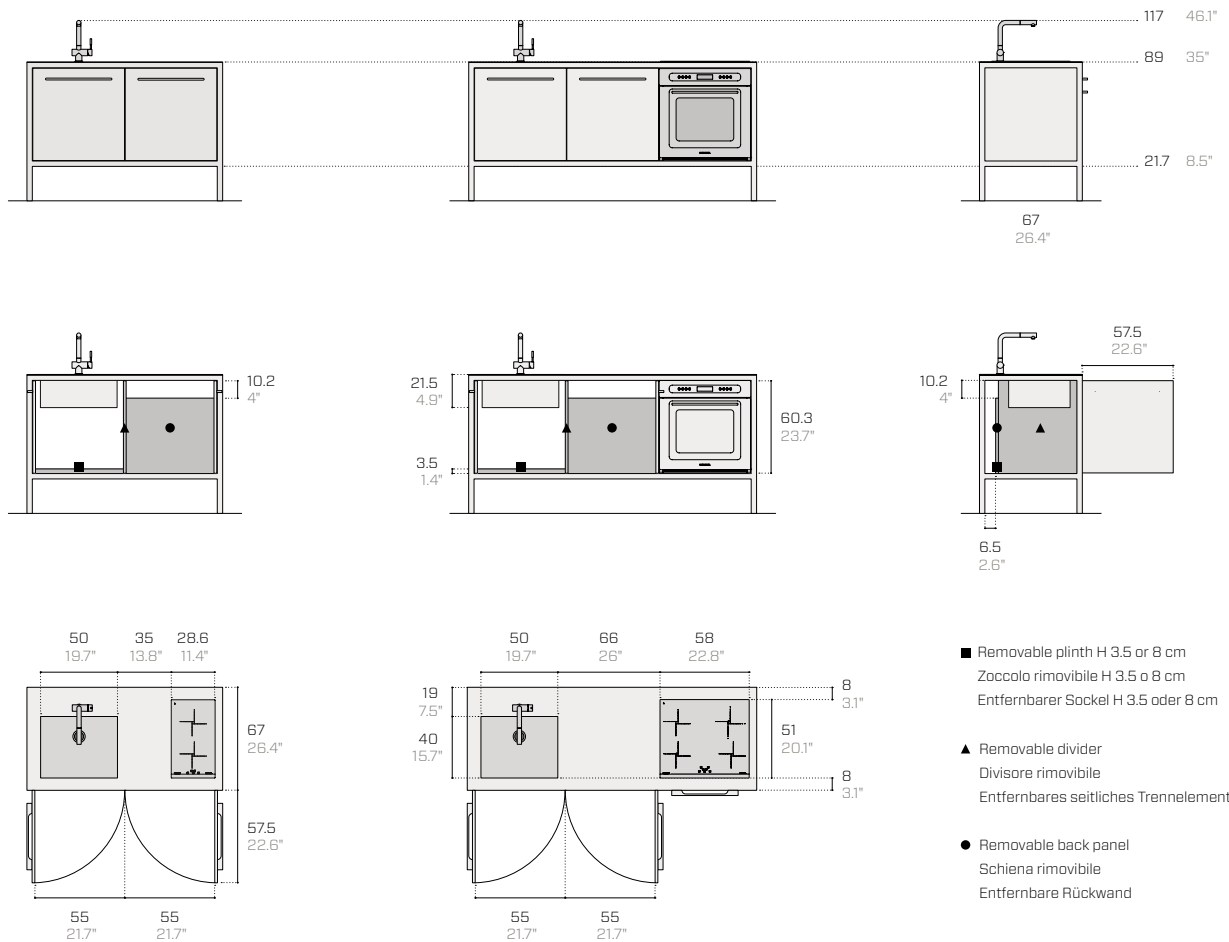

Product / Prodotto / Produkt				Packaging / Imballo / Verpackung			
No.	Code	Dimensions (w-d-h)	Weight	Dimensions (w-d-h)	Weight	Vol pkg	
N.	Codice	Dimensioni (l-p-h)	Peso	Dimensioni (l-p-h)	Peso	Vol. collo	
Nr.	Code	Abmessungen (b-t-h)	Gewicht	Abmessungen (b-t-h)	Gewicht	Vol. Kollo	
		cm	kg	cm	kg	mc	
Back panel for freestanding range / Schiena per cucina freestanding / Rückwand für freistehende Küche							
-	FR85SC113	120 62 4	10	125 70 10	12	0.10	
-	FR83SC109	180 62 4	15	185 70 10	18	0.20	
Floor attachment cover kit / Kit di copertura allacciamenti a pavimento / Set für Abdeckung der Anschlüsse am Boden							
-	FRB01	60 20 25	3	62 22 27	5	0.10	
Oven with Vintage finish (Barazza) / Forno con finitura Vintage (Barazza) / Backofen mit Vintage finish (Barazza)							
N	FRB02V	60 61 60	35	64 64 68	39	0.30	
Integrated dishwasher (Smeg) / Lavastoviglie integrata (Smeg) / Integrierter Geschirrspüler (Smeg)							
O	FRB04	56 55 58	-	- - -	-	-	
Induction hob (Barazza) / Piano a induzione (Barazza) / Induktionskochfeld (Barazza)							
P1	FRB05	58 51 0.4	12	87 60 13	14	0.10	
P2	FRB06	27 49 0.4	6	39 60 13	10	0.10	
Basin (Barazza) / Vasca sottotop con finitura satinata (Barazza) / Waschbecken (Barazza)							
Q	FRB08S	53 43 22	5	60 50 27	8	0.10	
Steel tap with Vintage finish (Barazza) / Rubinetto in acciaio finitura Vintage (Barazza) / Wasserhahn aus Stahl Vintage-Finish (Barazza)							
R1	FRB09V	13 26 27	5	59 25 10	8	0.10	
Steel tap with satin finish (Barazza) / Rubinetto in acciaio satinato (Barazza) / Wasserhahn aus Stahl satin-Finish (Barazza)							
R2	FRB10S	13 26 27	5	59 25 10	8	0.10	
Roll-up draining mat / Griglia multiuso avvolgibile (Barazza) / Aufrollbare Abtropfmatte (Barazza)							
S	FRB11	47 45 1	1	50 8 8	1	0.10	

**Bases / Basi / Basen**



**Top / Top / Abdeckung**

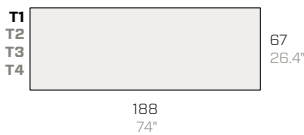

**Accessories and details / Accessori e dettagli / Zubehör und Details**



- ▲ Top (available in 4 versions)  
Top (disponibile in 4 versioni)  
Abdeckung (in 4 Versionen erhältlich)
- Lower shelves in metal (not replaceable)  
Ripiani inferiori in metallo (non sostituibili)  
Untere Regale aus Metall (nicht austauschbar)
- U. Full or perforated separator (freely positionable)  
Separatore pieno o forato (liberamente posizionabile)  
Voller oder perforierter Separator (frei positionierbar)

**Top thickness / Spessore del top / Plattenstärke**

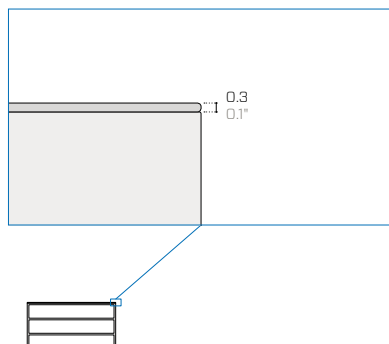

Metal top (not for food use)  
Top in metallo (non per uso alimentare)  
Abdeckung aus Metall (Nicht für Lebensmittel geeignet)

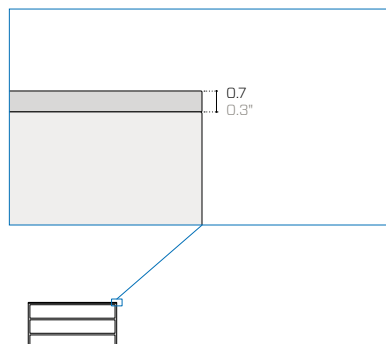

Fenix top  
Top in Fenix  
Abdeckung aus Fenix

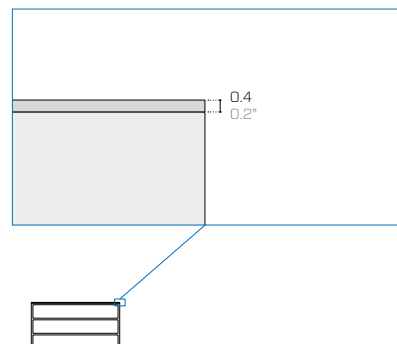

Stainless steel top  
Top in acciaio  
Abdeckung aus Edelstahl



Product / Prodotto / Produkt					Packaging / Imballo / Verpackung					
No.	Code	Dimensions (w-d-h)		Weight	Dimensions (w-d-h)		Weight	Vol pkg		
N.	Codice	Dimensioni (l-p-h)		Peso	Dimensioni (l-p-h)		Peso	Vol. collo		
Nr.	Code	Abmessungen (b-t-h)		Gewicht	Abmessungen (b-t-h)		Gewicht	Vol. Kollo		
			cm	kg		cm	kg	mc		
<b>Bases / Basi / Basen</b>										
<b>10</b>	FR81	188	67	89	100	192	71	119	110	1.70
Metal top (not for food use) / Top in metallo (non per uso alimentare) / Abdeckung aus Metall (Nicht für Lebensmittel geeignet)										
<b>T1</b>	FR81TOPS	188	67	0.3	23	192	71	10	28	0.20
Fenix top / Top in Fenix / Mit Platte in Fenix										
<b>T2</b>	FR851F	188	67	0.7	19	203	82	17	24	0.30
Satin finish stainless steel top (Barazza) / Top in acciaio Inox finitura satinata (Barazza) / Abdeckung in Edelstahl mit Satin-Finish (Barazza)										
<b>T3</b>	FR861S	188	67	0.4	40	197	80	21	50	0.40
Vintage finish stainless steel top (Barazza) / Top in acciaio Inox finitura Vintage (Barazza) / Top in Edelstahl mit Vintage-Finish (Barazza)										
<b>T4</b>	FR871V	188	67	0.4	40	197	80	21	50	0.40
Perforated separator / Separatore forato / Perforierter Separator										
<b>U1</b>	FR81TE622	188	28	4	5	190	30	5	10	0.11
Full separator / Separatore pieno / Voller Separator										
<b>U2</b>	FR81TE629	188	28	4	6	190	30	5	10	0.11

The packaging details are for products that require assembly / I dati di imballo si riferiscono al prodotto smontato / Die Verpackungsdaten beziehen sich auf das unmontierte Produkt



## Metal essentials

UM = Ultra matt / Ultra opaco / Ultra matt

MT = Matt / Opaco / Matt

EM = Embossed / Goffrato / Gaufriert

**01.18  
Black (RAL 9005)**

Nero / Schwarz

-

MT  
EM**08.18  
Rose quartz**

Rosa quarzo / Rosenquarz

-

MT

**15.19  
Forest green (RAL 6007)**

Verde bosco / Waldgrün

-

EM

**02.18  
Anthracite (RAL 7021)**

Antracite / Anthrazit

-

MT  
EM**09.18  
Ruby red (RAL 3003)**

Rosso rubino / Rubinrot

-

MT  
EM**16.19  
Turquoise blue (RAL 5018)**

Blu turchese / Türkisblau

-

EM

**03.18  
Fantin grey**

Grigio Fantin / Fantin-Grau

-

EM

**10.18  
Traffic red (RAL 3020)**

Rosso traffico / Verkehrsrot

-

MT  
EM**17.18  
Pastel blue (RAL 5024)**

Blu pastello / Pastellblau

-

MT  
EM**04.18  
Light grey (RAL 7035)**

Grigio luce / Lichtgrau

-

MT  
EM**11.18  
Pure orange (RAL 2004)**

Arancio puro / Reinorange

-

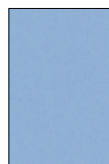
MT  
EM**18.18  
Serenity**

Serenity / Serenity

-

MT

**05.18  
Cloud grey**

Grigio nuvola / Wolkengrau

-

EM

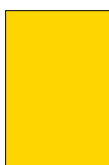
**12.19  
Zinc yellow (RAL 1018)**

Giallo zinco / Zinco gelb

-

EM

**19.18  
Gentian blue (RAL 5010)**

Blu genziana / Enzianblau

-

MT  
EM**06.18  
White (RAL 9016)**

Bianco / Weiß

-

MT  
EM**13.19  
Mint green (RAL 6024)**

Verde menta / Minzgrün

-

EM

**20.19  
Steel blue (RAL 5011)**

Blu acciaio / Stahlblau

-

EM

**07.18  
Pearl white (RAL 1013)**

Bianco perla / Perlweiß

-

MT  
EM**14.18  
Sage green (RAL 6021)**

Verde salvia / Salbeigrün

-

MT  
EM

## Metal design\*

UM = Ultra matt / Ultra opaco / Ultra matt

MT = Matt / Opaco / Matt

EM = Embossed / Goffrato / Gaufriert

## Ultra-matt\*

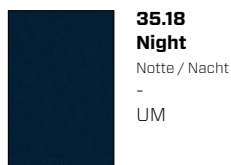
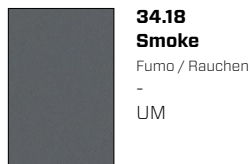
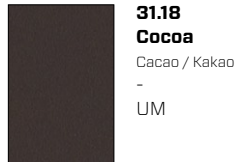

## Metallic\*

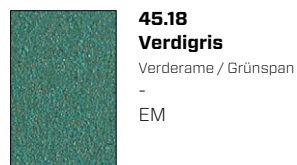
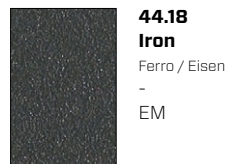
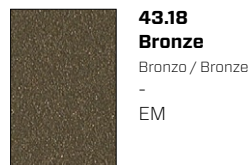
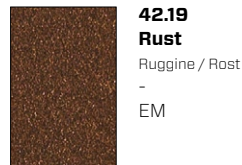
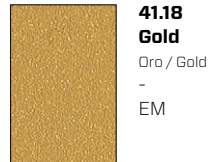

## Earth\*

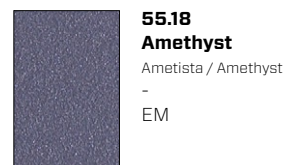
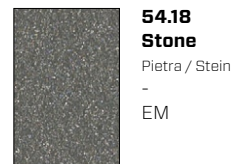
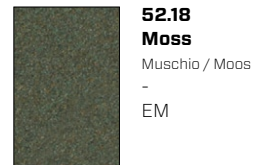

## Instructions for use / Indicazioni d'uso / Anwendungshinweise

Finishes  
Finiture  
Finishes

For tops  
Per i top  
Für die Abdeckungen

For outdoor use  
Per esterni  
Für den Außenbereich

UM = Ultra matt / Ultra opaco / Ultra matt  
MT = Matt / Opaco / Matt  
EM = Embossed / Goffrato / Gaufriert

-  
-  
+

-  
+  
+

---

**AISI 304 stainless steel**  
**Acciaio Inox AISI 304**  
**CNS AISI 304**

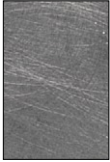

**K1.18**  
**Inox Vintage**

Inox Vintage / Inox Vintage



**K2.19**  
**Inox Satin**

Inox satinato / Inox satiniert

## Fenix NTM™

**Fenix NTM™ - Ultra-matt pairing**  
**Corrispondenza Fenix NTM™ - Ultra-matt**  
**Entsprechung Fenix NTM™ - Ultra-matt**

**F1.19**  
**Nero Ingo**

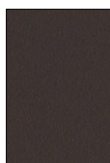
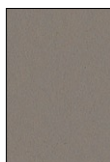
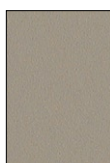
**F2.19**  
**Bianco Kos**

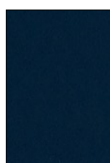
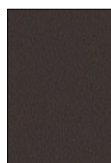
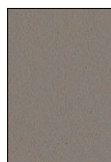
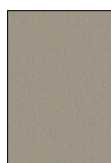
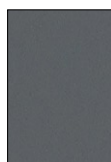
**F3.19**  
**Cacao Orinoco**

**F4.19**  
**Grigio Londra**

**F5.19**  
**Beige Arizona**

**F6.19**  
**Grigio Bromo**

**F7.19**  
**Blu Fes**

**31.18**  
**Cocoa**  
 Cacao / Kakao  
 -  
 UM

**32.18**  
**Dove grey**  
 Tortora / Taubengrau  
 -  
 UM

**33.18**  
**Hemp**  
 Canapa / Hanf  
 -  
 UM

**34.18**  
**Smoke**  
 Fumo / Rauchen  
 -  
 UM

**35.18**  
**Night**  
 Notte / Nacht  
 -  
 UM

The five "ultra-matt" finishes of the Fantin "Metal Design" collection are a perfect match for many Fenix NTM™ finishes in terms of colour, opacity and softness to the touch. This allows for monochrome products using Fantin solid metal structures and Fenix NTM™ resistant and restorable tops.

Le 5 finiture Ultra-matt della collezione Fantin "Metal Design" sono esattamente corrispondenti ad altrettante finiture Fenix NTM™, per colore, opacità e morbidezza al tatto. È così possibile ottenere prodotti monocromatici dalle solide strutture in metallo Fantin e con top resistenti e ripristinabili in Fenix NTM™.

Die fünf möglichen Oberflächen der Fantin Kollektion „Metal Design“ sind in harmonischer Abstimmung in Farb und Oberflächenempfindung mit den passenden Fenix NTM™ Oberflächen der Arbeitsplatte. So ist es möglich eine monolithische, unifarbene Gesamterscheinung der Fantin Strukturen mit dem widerstandsfähigen Arbeitsplattenoberflächen von Fenix NTM™ zu erzielen. Diese Arbeitsplatten wären im Bedarfsfall auch austauschbar.

### Technical information

**Metal** Non-toxic powder coating for interior use, with no heavy metals. Cured in an oven at 190°C, following degreasing and phosphating. Guaranteed minimum thickness of 50 microns. Minimum resistance to salt spray of 200 hours (in accordance with the ASTM B117 standard). Not suitable for direct contact with food as envisaged in Italian Ministerial Decree 21/03/73. Before the coating is added, it is possible to assess whether to give the products a special treatment to make them more resistant to wear and exposure to the elements. There is a surcharge for this treatment. Requests for other RAL finishes can be considered.

**AISI 304 stainless steel** Kitchen top with a thickness of 4 mm (0.16") with Vintage (exclusive Barazza manual processing, making it quicker and easier to maintain) or satin finish.

**Fenix** Top and stove tops in 7 mm (0.28") Fenix NTM™ thermolaminate with bottom fibreboard filler panel. Super matt, smudge-proof and restorable, gives the surface a warm aesthetic and is soft to the touch. Fenix NTM™ finishes are paired with the Fantin Ultra-matt (Metal Design) collection in the price list, in order to create monochrome products.

### Informazioni tecniche

**Metallo** Verniciatura per interni a polveri atossiche prive di metalli pesanti, con passaggio in forno a 190 °C, previo trattamento di sgrassaggio e fosfatazione. Spessore minimo garantito 50 micron, resistenza minima in nebbia salina pari a 200 ore (norma ASTM B117). Non idonea al contatto diretto con gli alimenti come previsto dal decreto italiano D.M. 21/03/73. Prima della verniciatura, è possibile valutare l'applicazione di un trattamento al fine di rendere i prodotti più resistenti all'uso e all'esposizione agli agenti atmosferici. Per tale trattamento è prevista una maggiorazione di prezzo. Altre finiture RAL valutabili su richiesta.

**Acciaio Inox AISI 304** Piano cucina spessore 4 mm (0.16") con finitura Vintage (lavorazione manuale esclusiva Barazza, la cui manutenzione è più semplice e agevole) o satinata.

**Fenix** Top e piani cucina in termolaminato Fenix NTM™ di spessore 7 mm (0.28") con tamponamento inferiore in fibre di legno. Super opaco, antimpronta e ripristinabile, dona alla superficie un'estetica calda e morbida al tatto. Le finiture Fenix NTM™ a listino sono corrispondenti alla collezione Fantin Ultra-matt (Metal Design), al fine di creare prodotti monocromatici.

### Technische Informationen

**Metall** Die Lackierung der gift- und schwermetallfreien Pulverlacke für Innenbereiche erfolgt im Lackierofen bei 190 °C nach vorheriger Entfettung und Phosphatierung. Die garantierte Mindeststärke der Lackschicht beträgt 50 Mikron bei einer Mindestprüfungsdauer von 200 Stunden im Salznebel (ASTM-Norm B117). Nicht für den direkten Kontakt mit Nahrungsmitteln geeignet, gemäß Ministerialdekret vom 21.03.1973 i.d.g.F. Vor der Lackierung kann die Anwendung einer Behandlung abgewägt werden, um die Produkte für den Gebrauch und gegen Witterungseinflüsse widerstandsfähiger zu machen. Für diese Behandlung ist ein Preisaufschlag vorgesehen. Auf Anfrage können andere RAL-Finishes in Betracht gezogen werden.

**Edelstahl CNS AISI 304** Küchenarbeitsplatte Stärke 4 mm (0.16") mit Vintage-Finish (exklusive Handverarbeitung Barazza, die leicht und bequem zu pflegen ist) oder satiniert.

**Fenix** Abdeckung und Küchenarbeitsplatten aus Thermolaminat Fenix NTM™ in der Stärke 7 mm (0.28") mit unterer Holzfaserdämmung. Die superopake Oberfläche mit Anti-Fingerprint-Schutz ist wiederherstellbar, hat eine warme Optik und eine weiche Haptik. Die Finishes Fenix NTM™ der Liste entsprechen denen der Kollektion Fantin Ultra-matt (Metal Design), sodass unifarbene Produkte entstehen.

**Kitchens and workbenches from the Frame range, with a visible support structure and inset doors and drawers that are distinguishing visual features of the minimal design scheme.**

**Frame** made of 35 x 35 mm (1.38" x 1.38") square tubes. Concealed adjustable feet.

**Top** made of Fenix with a thickness of 7 mm (0.28") with bottom fibreboard or AISI 304 stainless steel filler panel with a thickness of 4 mm (0.16") with satin or Vintage finish (with exclusive Barazza manual processing). Also available with integrated 500 x 400 x 219 mm (19.69" x 15.75" x 8.62") sink, steel tap with satin (1RUBMSTD) or Vintage finish (1RUBMSTDV) and Barazza induction hobs (1PIDG64N, 1PID32NQ).

**Top** (only for workbenches) made of metal with a thickness of 3 mm (0.12") and a bottom fibreboard filler panel. Not suitable for food use.

**Doors** inset in the frame, made of bent and filled sheet metal. Door thickness: 20 mm (0.79"). Metal handles with a coating in a colour to match the doors. Soft-close dampening hinges.

**Drawers** with fronts inset in the frame, made of bent and filled sheet metal. Drawer front thickness: 20 mm (0.79"). Metal handles with a coating in a colour to match the drawer fronts. Drawers with built-in stabilization and soft-close systems. Capacity: 40 kg (88.18 lb).

**Sides and bases** inset in the frame, made of bent and filled sheet metal.

**Metal backboards** inset in the frame.

**Inside shelves** made of bent sheet metal.

**Optional oven** Barazza Unique Multi-program Touch Control model, width: 60 cm (1FUNPV).

**Optional dishwasher** Smeg STC75.

This product requires assembly (it comes with welded single-piece frames).

On request, starting October 2019, the product will be available for outdoor use, thanks to a cataphoretic coating treatment that prevents rusting.

**Cucine e banconi del programma Frame, caratterizzato dal telaio portante in vista ed ante e cassetti in luce, che diventano caratteristiche estetiche dal design minimale.**

**Telaio** in tubolare quadrato 35 x 35 mm (1.38" x 1.38"). Piedini invisibili regolabili.

**Top** in Fenix di spessore 7 mm (0.28") con tamponamento inferiore in fibre di legno o in acciaio Inox AISI 304 di spessore 4 mm (0.16") con finitura satinata o Vintage (lavorazione manuale esclusiva Barazza). Disponibile anche con vasca integrata 500 x 400 x 219 mm (19.69" x 15.75" x 8.62"), rubinetto in acciaio con finitura satinata (1RUBMSTD) o Vintage (1RUBMSTDV) e piani cottura a induzione Barazza (1PIDG64N, 1PID32NQ).

**Top** in metallo (solo per banconi) in metallo di spessore 3 mm (0.12") con tamponamento inferiore in fibre di legno. Non adatto per uso alimentare.

**Ante** in luce al telaio, in lamiera piegata e tamponata. Spessore delle ante 20 mm (0.79"). Maniglie in metallo verniciate in tinta con le ante. Cerniere ammortizzate.

**Cassetti** con frontali in luce al telaio spessore 20 mm (0.79"), in lamiera piegata e tamponata. Maniglie in metallo verniciate in tinta con i frontali dei cassetti. Cassetti con sistemi di stabilizzazione e soft-close integrati con portata 40 kg (88.18 lb).

**Fianchi e fondi** in luce al telaio, in lamiera piegata e tamponata.

**Schiene** in metallo in luce al telaio.

**Ripiani** interni in lamiera piegata.

**Forno opzionale** Barazza modello Unique Multiprogram Touch Control da 60 cm di larghezza (1FUNPV).

**Lavastoviglie opzionale** Smeg STC75.

Il prodotto viene fornito smontato (telaio monoblocco saldati).

Su richiesta, da ottobre 2019 il prodotto sarà disponibile per outdoor, grazie a un trattamento di cataforesi che previene la formazione della ruggine.

**Küchen und Werkbänke aus der Frame-Linie mit sichtbarem Tragegestell und bündigen Türen und Schubladen, die zu den ästhetischen Eigenschaften eines Minimaldesigns werden.**

**Gestell** aus Vierkantrohr 35 x 35 mm (1.38" x 1.38"). Unsichtbare, einstellbare Füße.

**Abdeckung** in Fenix, Stärke 7 mm (0.28") mit unterer Holzfaserdämmung oder Beschichtung aus Edelstahl CNS AISI 304 in Stärke 4 mm (0.16") mit Satin- oder Vintage-Finish (exklusive Handverarbeitung Barazza). Ebenfalls verfügbar mit integriertem Waschbecken 500 x 400 x 219 mm (19.69" x 15.75" x 8.62"), Wasserhahn aus Stahl mit Satin-Finish (1RUBMSTD) oder Vintage-Finish (1RUBMSTDV) und Induktionskochfelder Barazza (1PIDG64N, 1PID32NQ).

**Abdeckung** (nur für Werkbänke) aus 3 mm (0.12") starkem Metall mit unterer Holzfaserdämmung. Nicht für Lebensmittel geeignet.

**Türen** aus gedämmtem Falzblech, bündig mit dem Gestell. Stärke der Türen 20 mm (0.79"). Lackierte Metallgriffe gleichfarbig mit den Türen. Gedämpfte Scharniere.

**Schubladen** aus gedämmtem Falzblech, mit Fronten bündig mit dem Gestell. Schubladenfrontstärke: 20 mm (0.79"). Lackierte Metallgriffe gleichfarbig mit den Schubladenfronten. Schubladen mit Stabilisations- und Soft-Close-Systemen und mit einer Tragfähigkeit von 40 kg (88.18 lb).

**Seiten und Basen** aus gedämmtem Falzblech, bündig mit dem Gestell.

**Rückwände** aus Metall, bündig mit dem Gestell.

**Innere Einlegeböden** aus Falzblech.

**Optionaler Backofen** Barazza Modell Unique Multi-Programm, Touch Control, Breite 60 cm (1FUNPV).

**Option Geschirrspülmaschine** Smeg STC75.

Das Produkt wird unmontiert geliefert (geschweißte einteilige Gestelle).

Auf Wunsch ist ab Oktober 2019 auch ein Produkt für den Außenbereich erhältlich, da dank einer kataphoretischen Behandlung die Rostbildung verhindert wird.

**Disclaimer / Esclusione di responsabilità / Haftungsausschluss**

Fantin Srl reserves the right to change the dimensions and features of the products contained in this technical data sheet at any time and without prior notice. The finishes illustrated are purely indicative as the accuracy tolerances of printing processes should be taken into account.

Fantin Srl si riserva la facoltà di modificare in qualsiasi momento e senza preavviso le dimensioni e l'esecuzione dei prodotti contenuti nella presente scheda tecnica. Le finiture riportate hanno valore indicativo in quanto soggette alle tolleranze dei processi di stampa.

Fantin Srl behält sich das Recht vor, die angegebenen Maße und Ausführungen der Produkte, welche dieses Produktblatt enthält, jederzeit ohne Vorankündigung zu ändern. Aufgrund drucktechnischer Abweichungen dienen die dargestellten Ausführungen nur der Illustration.

**Fantin Srl**

via San Vito, 43  
33080 - Bannia  
di Fiume Veneto (PN)  
Italia

t +39 0434 959 133  
f +39 0434 560 037  
fantin@fantin.com  
www.fantin.com



UNI EN ISO 9001